

STAINLESS STEEL GAS FLEX - 3/8"



For Yellow Gas Flex add a "Y" to the P/N
Example: 01-Y348

P/N	LENGTH	CASE QUAN
01-312	12"	25
01-318	18"	25
01-324	24"	25
01-330	30"	25
01-336	36"	25
01-348	48"	25
01-360	60"	25
01-372	72"	25

GAS VALVES - 3/8" Flare



P/N	ITEM DESC
01-380G	3/8" FLARE x 1/2" FIP ANGLE
01-387	3/8" FLARE x 1/2" FIP STRAIGHT

FLARE FITTINGS - 3/8"



P/N	ITEM DESC
01-390	3/8" FLARE x 3/8" FIP
01-392	3/8" FLARE x 1/2" FIP
01-395	3/8" FLARE x 3/8" MIP (& 1/4" FIP)
01-396	3/8" FLARE x 1/2" MIP (& 3/8" FIP)
01-399	3/8" FLARE x 3/8" FIP ELBOW

GAS FLEX COMBOS - 3/8"

These are 8 of our most popular Gas Flex Combos for 3/8" Gas Flex. Add the -XX number to the Gas Flex Part Number to get these Combos.

EXAMPLE: 01-348-63G is a 48 inch Gas Flex with 1/2" Angle Gas Valve on one end and a 3/8" FIP Adapter on the other end.

Other configurations are available, ask your sales representative.

-01		P/N 01-396		P/N 01-392
-02		P/N 01-396		P/N 01-396
-03		P/N 01-396		P/N 01-390
-40		P/N 01-396		None
-43		P/N 01-390		None
-60G		P/N 01-380G		P/N 01-396
-63G		P/N 01-380G		P/N 01-390
-70		P/N 01-387		P/N 01-396

STAINLESS STEEL GAS FLEX - 1/2"



For Yellow Gas Flex add a "Y" to the P/N
 Example: 01-Y424

P/N	LENGTH	CASE QUAN
01-412	12"	25
01-418	18"	25
01-424	24"	25
01-430	30"	25
01-436	36"	25
01-448	48"	25
01-460	60"	25
01-472	72"	25

GAS VALVES - 1/2" Flare



P/N	ITEM DESC
01-480G	1/2" FLARE x 1/2" FIP ANGLE



P/N	ITEM DESC
01-487	1/2" FLARE x 1/2" FIP STRAIGHT



P/N	ITEM DESC
01-488	1/2" FLARE x 3/4" FIP STRAIGHT

FLARE FITTINGS - 1/2"



P/N	ITEM DESC
01-490	1/2" FLARE x 3/8" FIP



P/N	ITEM DESC
01-492	1/2" FLARE x 1/2" FIP



P/N	ITEM DESC
01-493	1/2" FLARE x 3/4" FIP



P/N	ITEM DESC
01-495	1/2" FLARE x 3/8" MIP (& 1/4" FIP)



P/N	ITEM DESC
01-496	1/2" FLARE x 1/2" MIP (& 3/8" FIP)



P/N	ITEM DESC
01-499	1/2" FLARE x 3/8" FIP ELBOW



P/N	ITEM DESC
01-497	1/2" FLARE x 3/4" MIP

GAS FLEX COMBOS - 1/2"

These are 8 of our most popular Gas Flex Combos for 1/2" Gas Flex. Add the -XX number to the Gas Flex Part Number to get these Combos.

EXAMPLE: 01-448-60G is a 48 inch Gas Flex with 1/2" Angle Gas Valve on one end and a 1/2" MIP Adapter on the other end.

Other configurations are available, ask your sales representative.

-01		P/N 01-496		P/N 01-492
-02		P/N 01-496		P/N 01-496
-03		P/N 01-496		P/N 01-490
-05		P/N 01-496		P/N 01-499
-11		P/N 01-492		P/N 01-490
-40		P/N 01-496		None
-60G		P/N 01-480G		P/N 01-496
-70		P/N 01-487		P/N 01-496

STAINLESS STEEL GAS FLEX - 15/16"



For Yellow Gas Flex add a "Y" to the P/N
Example: 01-Y672

P/N	LENGTH	CASE QUAN
01-612	12"	25
01-618	18"	25
01-624	24"	25
01-630	30"	25
01-636	36"	25
01-648	48"	25
01-660	60"	25
01-672	72"	25

GAS VALVES - 15/16" Flare



P/N	ITEM DESC
01-680G	15/16" FLARE x 3/4" FIP ANGLE

P/N	ITEM DESC
01-687	15/16" FLARE x 3/4" FIP STRAIGHT

P/N	ITEM DESC
01-688	15/16" FLARE x 1/2" FIP STRAIGHT

FLARE FITTINGS - 15/16"



P/N	ITEM DESC
01-692	15/16" FLARE x 1/2" FIP

P/N	ITEM DESC
01-693	15/16" FLARE x 3/4" FIP

P/N	ITEM DESC
01-696	15/16" FLARE x 1/2" MIP (& 3/8" FIP)

P/N	ITEM DESC
01-697	15/16" FLARE x 3/4" MIP (& 1/2" FIP)

P/N	ITEM DESC
01-699	15/16" FLARE x 3/4" FIP ELBOW

P/N	ITEM DESC
01-800	15/16" MALE FLARE to 5/8" FEMALE FLARE

P/N	ITEM DESC
01-698	15/16" FLARE CAP

GAS FLEX COMBOS - 15/16"

These are 8 of our most popular Gas Flex Combos for 15/16" Gas Flex. Add the -XX number to the Gas Flex Part Number to get these Combos.

EXAMPLE: 01-672-07 is a 72 inch Gas Flex with 1/2" MIP Adapter on one end and a 3/4" MIP Adapter on the other end.

Other configurations are available, ask your sales representative.

-01		P/N 01-696		P/N 01-692
-02		P/N 01-696		P/N 01-696
-07		P/N 01-696		P/N 01-697
-08		P/N 01-696		P/N 01-693
-26		P/N 01-697		P/N 01-697
-28		P/N 01-697		P/N 01-693
-40		P/N 01-696		None
-90G		P/N 01-680G		P/N 01-696

STAINLESS STEEL GAS FLEX - 7/8" w/ 5/8" Flare Nuts



P/N	ITEM DESC	LENGTH
01-712	12"	12"
01-718	18"	18"
01-724	24"	24"
01-730	30"	30"
01-736	36"	36"
01-748	48"	48"
01-760	60"	60"
01-772	72"	72"

GAS VALVES - 5/8" Flare



P/N	ITEM DESC
01-787	5/8" FLARE x 3/4" FIP STRAIGHT

FLARE FITTINGS - 5/8"



P/N	ITEM DESC
01-792	5/8" FLARE x 1/2" FIP



P/N	ITEM DESC
01-793	5/8" FLARE x 3/4" FIP



P/N	ITEM DESC
01-796	5/8" FLARE x 1/2" MIP



P/N	ITEM DESC
01-797	5/8" FLARE x 3/4" MIP



P/N	ITEM DESC
01-799	5/8" FLARE x 3/4" FIP ELBOW



P/N	ITEM DESC
01-800	15/16" MALE FLARE to 5/8" FEMALE FLARE

GAS FLEX COMBOS - 7/8"

Here are 4 of our most popular Gas Flex Combos for 7/8" Gas Flex. Add the -XX number to the Gas Flex Part Number to get these Combos.

EXAMPLE: 01-748-40 is a 48 inch Gas Flex with 1/2" MIP Adapter on one end and no fitting on the other end.

Other configurations are available, ask your sales representative.

-01		P/N 01-796		P/N 01-792
-02		P/N 01-796		P/N 01-796
-07		P/N 01-796		P/N 01-797
-40		P/N 01-796		None

GAS FLEX w/ 15/16" and 5/8" Flare Nuts

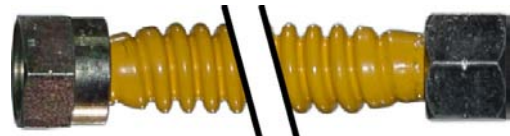

P/N	ITEM DESC
01-548	4 Foot w/ 15/16" Flare Nut and 5/8" Flare Nut

STAINLESS STEEL GAS FLEX - 1 1/8"

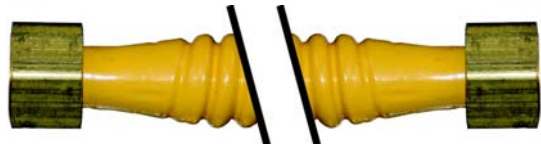

P/N	LENGTH
01-912	12"
01-924	24"
01-936	36"
01-948	48"
01-960	60"
01-972	72"

GAS VALVE - AGA Approved



Gas Valves - FIP x FIP

P/N	SIZE	CASE QUAN
01-2808	1/2" FIP x 1/2" FIP	12
01-2812	3/4" FIP x 3/4" FIP	12

PIPE JOINT COMPOUNDS

RECTORSEAL #5

P/N	ITEM DESC
49-8000	1 3/4 oz.
49-8004	4 oz.
49-8008	8 oz.



HERCULES 'PRO-DOPE'

P/N	ITEM DESC
49-8408	8 oz.



TEFLON TAPE - AGA Approved for Gas



P/N	ITEM DESC
49-92	Yellow - 1/2" x 260"

TEFLON TAPE



P/N	ITEM DESC
49-90	White - 1/2" x 260"
49-91	White - 1/2" x 520"
49-94	White - 3/4" x 520"

LA-CO 'SLIC-TITE' - TEFLON TYPE

P/N	ITEM DESC
49-9504	4 oz.
49-9508	8 oz.



PIPE DOPE

P/N	ITEM DESC
49-9700	2 oz. TUBE



PIPETITE STICKS



P/N	ITEM DESC
49-9600	EACH
49-9600-12	BOX of 12

LA-CO 'T-O-T' - SILICONIZED

P/N	ITEM DESC
49-9808	8 oz.



LEAK DETECTOR - HI VISCOSITY

'BUBBLE LEAK'

P/N	ITEM DESC
01-8738	8 oz. BOTTLE
01-8739	8 oz. BOTTLE FLOURESCENT



'BUBBLE LEAK' KIT

P/N	ITEM DESC
01-8SCK	SEAL 'N CHECK KIT



PIPE HEX BUSHINGS



P/N	ITEM DESC	SIZE
40-400804	GALVANIZED	1/2" x 1/4"
40-400806	GALVANIZED	1/2" x 3/8"
40-401208	GALVANIZED	3/4" x 1/2"
42-400804	BLACK MALLEABLE	1/2" x 1/4"
42-400806	BLACK MALLEABLE	1/2" x 3/8"
42-401208	BLACK MALLEABLE	3/4" x 1/2"

PIPE BELL REDUCERS



P/N	ITEM DESC	SIZE
40-220806	GALVANIZED	1/2" x 3/8"
40-221208	GALVANIZED	3/4" x 1/2"
42-220806	BLACK MALLEABLE	1/2" x 3/8"
42-221208	BLACK MALLEABLE	3/4" x 1/2"

PIPE ELBOWS - 90 degrees



P/N	ITEM DESC	SIZE
40-0106	GALVANIZED	3/8"
40-0108	GALVANIZED	1/2"
40-0112	GALVANIZED	3/4"
42-0106	BLACK MALLEABLE	3/8"
42-0108	BLACK MALLEABLE	1/2"
42-0112	BLACK MALLEABLE	3/4"

PIPE STREET ELBOWS



P/N	ITEM DESC	SIZE
40-0206	GALVANIZED	3/8"
40-0208	GALVANIZED	1/2"
40-0212	GALVANIZED	3/4"
42-0206	BLACK MALLEABLE	3/8"
42-0208	BLACK MALLEABLE	1/2"
42-0212	BLACK MALLEABLE	3/4"

PIPE COUPLINGS



P/N	ITEM DESC	SIZE
40-2006	GALVANIZED	3/8"
40-2008	GALVANIZED	1/2"
40-2012	GALVANIZED	3/4"
42-2006	BLACK MALLEABLE	3/8"
42-2008	BLACK MALLEABLE	1/2"
42-2012	BLACK MALLEABLE	3/4"

PIPE TEES



P/N	ITEM DESC	SIZE
40-5004	GALVANIZED	1/4"
40-5006	GALVANIZED	3/8"
40-5008	GALVANIZED	1/2"
40-5012	GALVANIZED	3/4"
42-5004	BLACK MALLEABLE	1/4"
42-5006	BLACK MALLEABLE	3/8"
42-5008	BLACK MALLEABLE	1/2"
42-5012	BLACK MALLEABLE	3/4"

PIPE REDUCING ELBOWS



P/N	ITEM DESC	SIZE
40-030806	GALVANIZED	1/2" x 3/8"
40-031208	GALVANIZED	3/4" x 1/2"
42-030806	BLACK MALLEABLE	1/2" x 3/8"
42-031208	BLACK MALLEABLE	3/4" x 1/2"

PIPE CAPS



P/N	ITEM DESC	SIZE
40-4508	GALVANIZED	1/2"
40-4512	GALVANIZED	3/4"
42-4508	BLACK MALLEABLE	1/2"
42-4512	BLACK MALLEABLE	3/4"

PIPE PLUGS



P/N	ITEM DESC	SIZE
40-4608	GALVANIZED	1/2"
40-4612	GALVANIZED	3/4"
42-4608	BLACK MALLEABLE	1/2"
42-4612	BLACK MALLEABLE	3/4"

PIPE NIPPLES - GALVANIZED

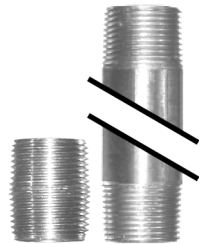

P/N	SIZE
41-0600	3/8" x CLOSE
41-0601	3/8" x 1 1/2"
41-0602	3/8" x 2"
41-0603	3/8" x 2 1/2"
41-0800	1/2" x CLOSE
41-0801	1/2" x 1 1/2"
41-0802	1/2" x 2"
41-0803	1/2" x 2 1/2"
41-1200	3/4" x CLOSE
41-1201	3/4" x 1 1/2"
41-1202	3/4" x 2"
41-1203	3/4" x 2 1/2"

PIPE NIPPLES - BLACK MALLEABLE



P/N	SIZE
43-0600	3/8" x CLOSE
43-0601	3/8" x 1 1/2"
43-0602	3/8" x 2"
43-0603	3/8" x 2 1/2"
43-0800	1/2" x CLOSE
43-0801	1/2" x 1 1/2"
43-0802	1/2" x 2"
43-0803	1/2" x 2 1/2"
43-1200	3/4" x CLOSE
43-1201	3/4" x 1 1/2"
43-1202	3/4" x 2"
43-1203	3/4" x 2 1/2"

3 WIRE DRYER CORDS



220V 30 AMP DRYER CORDS

P/N	LENGTH	U/M	CASE QUAN	PKG
60-04A	4'	EA	12	BAGGED
60-05A	5'	EA	12	BAGGED
60-06A	6'	EA	12	BAGGED
60-10A	10'	EA	12	BAGGED



220V 30 AMP OPEN TERMINAL DRYER CORDS

P/N	LENGTH	U/M	CASE QUAN	PKG
60-04TA	4'	EA	12	BAGGED
60-05TA	5'	EA	12	BAGGED
60-06TA	6'	EA	12	BAGGED

3 WIRE RANGE CORDS



220V 40 AMP RANGE CORDS

P/N	LENGTH	U/M	CASE QUAN	PKG
60-14-40A	4'	EA	12	BAGGED

220V 50 AMP RANGE CORDS

P/N	LENGTH	U/M	CASE QUAN	PKG
60-14A	4'	EA	12	BAGGED
60-15A	5'	EA	12	BAGGED
60-16A	6'	EA	12	BAGGED
60-20A	10'	EA	12	BAGGED



220V 50 AMP OPEN TERMINAL RANGE CORDS

P/N	LENGTH	U/M	CASE QUAN	PKG
60-14TA	4'	EA	12	BAGGED
60-15TA	5'	EA	12	BAGGED
60-16TA	6'	EA	12	BAGGED

4 WIRE DRYER CORDS



220V 30 AMP DRYER CORDS

P/N	LENGTH	U/M	CASE QUAN	PKG
60-54A	4'	EA	12	BAGGED
60-55A	5'	EA	12	BAGGED
60-56A	6'	EA	12	BAGGED
60-60A	10'	EA	12	BAGGED

4 WIRE RANGE CORDS



220V 40 AMP RANGE CORDS

P/N	LENGTH	U/M	CASE QUAN	PKG
60-44-40A	4'	EA	12	BAGGED

220V 50 AMP RANGE CORDS

P/N	LENGTH	U/M	CASE QUAN	PKG
60-44A	4'	EA	12	BAGGED
60-45A	5'	EA	12	BAGGED
60-46A	6'	EA	12	BAGGED

RANGE and DRYER RELIEF CLAMPS



60-DCLAMP



60-CLAMP

METAL

P/N	ITEM DESC
60-CLAMP	for RANGE CORD
60-DCLAMP	for DRYER CORD

110V GENERAL PURPOSE CORDS



110V STRAIGHT CORDS FOR DISPOSERS, DISHWASHERS, FURNACES

P/N	LENGTH	U/M	PKG
60-83	3'	EA	BULK
60-84	4'	EA	BULK
60-85	5'	EA	BULK
60-86	6'	EA	BULK
60-88	8'	EA	BULK



110V ANGLE CORDS FOR DISPOSERS, DISHWASHERS, FURNACES

P/N	LENGTH	U/M	PKG
60-93	3'	EA	BULK
60-94	4'	EA	BULK
60-95	5'	EA	BULK
60-96	6'	EA	BULK
60-98	8'	EA	BULK

EXTENSION CORDS



110V 3 WIRE AC EXTENSION CORDS

P/N	LENGTH	U/M	CASE QUAN	PKG
60-30	3'	EA	12	BULK
60-31	6'	EA	12	BULK
60-32	9'	EA	12	BULK
60-33	12'	EA	12	BULK

CORD CAP - RANGE and DRYER



220V w/ 30A and 50A BLADES

P/N	ITEM DESC	U/M	PKG
61-80	3-WIRE	EA	BULK
61-21	4-WIRE	EA	BULK

RELIEF CLAMPS



63-0051



63-0104
63-0105



63-0110
63-0111
63-0112



63-044-1

METAL

P/N	ITEM DESC
63-0051	1/2" K.O.
63-0104	3/4" K.O.
63-0105	1" K.O.
63-0110	3/8" K.O.
63-0111	1/2" K.O.
63-0112	3/4" K.O.
63-044-1	1/2" K.O.

63-0051PL
63-0052PL



63-3201
63-3202

PLASTIC

P/N	ITEM DESC
63-0051PL	1/2" K.O.
63-0052PL	3/4" K.O.
63-3201	1/2" K.O.
63-3202	3/4" K.O.

SURFACE MOUNT RECEPTACLES



220V

P/N	ITEM DESC	U/M	PKG
61-125	3 WIRE DRYER	EA	BULK
61-1225	4 WIRE DRYER	EA	BULK
61-112	3 WIRE RANGE	EA	BULK
61-1212	4 WIRE RANGE	EA	BULK

FLUSH MOUNT RECEPTACLES



220V

P/N	ITEM DESC
61-38	3 WIRE 30A DRYER
61-278B	4 WIRE 30A DRYER
61-32	3 WIRE 50A RANGE
61-279B	4 WIRE 50A RANGE

CHROME COVER PLATE



FITS 61-32 and 61-38

P/N	ITEM DESC
61-68	220V CHROME WALL PLATE

ELECTRICAL BOXES



STEEL

P/N	ITEM DESC
63-7595	2" x 4"
63-7588	4" x 4"
63-3210	1/2" PLASTIC K.O. BUSHING

PIPE STRAP



GALVANIZED

P/N	SIZE
63-MTW8	1/2"
63-MTW12	3/4"
63-MTW16	1"

CABLE CLAMPS



NYLON

P/N	SIZE	U/M
65-1045	1/4"	100L
65-1046	3/8"	100L
65-1047	1/2"	25L

CABLE TIES

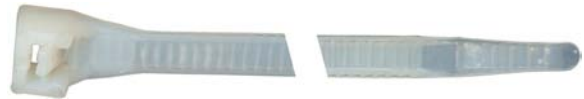

NYLON

P/N	SIZE	U/M
65-1180	4"	100L
65-1182	6"	100L
65-1183	11"	100L
65-1184	14"	100L

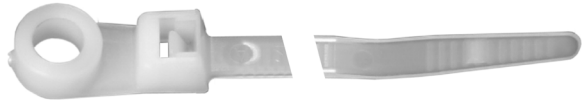

NYLON w/ SCREW MOUNT HEAD

P/N	SIZE	U/M
65-1189	7"	100L
65-1188	11"	100L

ELECTRICAL ADAPTERS and CONNECTORS



P/N	ITEM DESC	U/M	PKG
61-01	2-3 WIRE ADAPTER	EA	BULK
61-1147	IVORY TRIPLE GROUNDING TAP	EA	BULK
61-1482	IVORY 3 WAY CUBE TAP	EA	BULK
61-209	3 PRONG RUBBER CORD CAP	EA	BULK
61-2228	110V CORD CONECTOR	EA	BULK

ELECTRICAL OUTLETS and SWITCHES



P/N	ITEM DESC
61-1301V	SILENT SWITCH - IVORY
61-1877V	20 AMP SINGLE OUTLET
61-827	15 AMP DUPLEX OUTLET
61-877	20 AMP DUPLEX OUTLET

WIRENUTS



HARD PLASTIC

P/N	ITEM DESC	U/M
65-329XTP	GRAY 14-8	100L
65-330XTP	BLUE	100L
65-331XTP	ORANGE 18-16	100L
65-333XTP	YELLOW 18-12	100L
65-335XTP	RED 18-10	100L



WINGED SOFT VINYL

P/N	ITEM DESC	U/M
65-733TT	YELLOW	100L
65-735TT	RED	100L
65-739TT	BLUE	50L



NOALUX

P/N	ITEM DESC	U/M
65-30-265	ALUMINUM to COPPER Connection	100L

WALL PLATES



PLASTIC

P/N	ITEM DESC
61-2131V	IVORY - SINGLE OUTLET
61-2132V	IVORY - DUPLEX OUTLET
61-2132W	WHITE - DUPLEX OUTLET



STEEL

P/N	ITEM DESC
63-7606	4" SQUARE w/ 1/2" CTR K.O.
63-7607	4" X 4" SOLID COVER
63-7608	4" SQUARE for 2" X 4" BOX
63-7622	2" X 4" SOLID COVER
63-7623	2" X 4" w/ CENTER K.O.

RISER 1/4"C x 1/4"C I/M LINE

NEW !

w/ Elbow



SS and BLUE VINYL BRAIDED

P/N	LENGTH
04-90112SSL	12 inch SS
04-90160SSL	60 inch SS
04-90172SSL	72 inch SS
04-90160L	60 inch Blue Vinyl
04-90172L	72 inch Blue Vinyl

BLUE VINYL BRAIDED



P/N	LENGTH
04-90112	12 inch
04-90124	24 inch
04-90136	36 inch
04-90148	48 inch
04-90160	60 inch
04-90172	72 inch
04-90210	10 foot
04-90215	15 foot
04-90220	20 foot
04-90225	25 foot

WHITE VINYL BRAIDED



P/N	LENGTH
04-90112W	12 inch
04-90124W	24 inch
04-90136W	36 inch
04-90148W	48 inch
04-90160W	60 inch
04-90172W	72 inch
04-90210W	10 foot
04-90215W	15 foot
04-90220W	20 foot
04-90225W	25 foot

SS BRAIDED



P/N	LENGTH
04-90112SS	12 inch
04-90124SS	24 inch
04-90136SS	36 inch
04-90148SS	48 inch
04-90160SS	60 inch
04-90172SS	72 inch
04-90210SS	10 foot
04-90215SS	15 foot
04-90220SS	20 foot
04-90225SS	25 foot

SS BRAIDED Large Mouth



P/N	LENGTH
04-L60SS	60 inch
04-L72SS	72 inch
04-L96SS	96 inch

ANGLE STOPS - 1/4"C



1/2" NOM x 1/4" COMPRESSION

P/N	ITEM DESC
21-3844	BRASS
21-3944	CHROME
21-AB44BK	CHROME - 1/4 TURN BALL VALVE - IMPORT



1/2" IP x 1/4" COMPRESSION

P/N	ITEM DESC
21-3804	BRASS
21-3904	CHROME

BRASS COMPRESSION UNIONS



P/N	ITEM DESC
05-B62-4	1/4" no Nuts or Sleeves
05-62-4	1/4" with Nuts and Sleeves
05-62R-6-4	3/8" to 1/4" Reducer

ICE MAKER FILTERS



Reduces Bad Taste & Odor - includes Scale Inhibitors individually Bagged w/ Compression Fittings

P/N	ITEM DESC
14-OSCL64Z	6" (750 gallons)
14-OSCL104Z	10" (1500 gallons)
14-OSCL124Z	12" (2000 gallons)

RISER 3/8" C x 3/8" C D/W LINE



REDLINE High-Performance

P/N	LENGTH
21-78448R	48 inch
21-78460R	60 inch
21-78472R	72 inch
21-78496R	96 inch
21-78210R	10 foot



VINYL BRAIDED

P/N	LENGTH
21-78409	9 inch
21-78412	12 inch
21-78416	16 inch
21-78420	20 inch
21-78424	24 inch
21-78430	30 inch
21-78436	36 inch
21-78448	48 inch
21-78460	60 inch
21-78472	72 inch
21-78496	96 inch



SS BRAIDED

P/N	LENGTH
21-82409	9 inch
21-82412	12 inch
21-82416	16 inch
21-82420	20 inch
21-82424	24 inch
21-82430	30 inch
21-82436	36 inch
21-82448	48 inch
21-82460	60 inch
21-82472	72 inch
21-82496	96 inch
21-824144	12 foot



SS BRAIDED Large Mouth

P/N	LENGTH
21-L72SS	72 inch

DISHWASHER ELBOW



3/8" C x 3/8" MIP

P/N	ITEM DESC
05-B69-6-6A	no Nut or Sleeve
05-69-6-6	with Nut and Sleeve

ANGLE STOPS - 3/8" C



1/2" NOM x 3/8" C

P/N	ITEM DESC
21-3846	BRASS
21-3946	CHROME
21-AB46BK	CHROME - 1/4 TURN BALL VALVE - IMPORT
21-1900	CHROME - 1/4 TURN BALL VALVE - ARCO



1/2" IP x 3/8" C

P/N	ITEM DESC
21-3806	BRASS
21-3906	CHROME
21-1901	CHROME - 1/4 TURN BALL VALVE - ARCO

BRASS COMPRESSION UNIONS



P/N	ITEM DESC
05-B62-6	3/8" no Nuts or Sleeves
05-62-6	3/8" with Nuts and Slevves

D/W INSTALLATION PARTS



P/N	ITEM DESC
50-35	DRAIN HOSE 5/8" ID x 50ft
50-37	DRAIN HOSE 7/8" ID x 50ft
50-38	PLASTIC AIR GAP
50-382046	DRAIN ADAPTER w/ CLAMPS
50-912	HOSE CLAMP 1/2" to 1 1/4"
50-916	HOSE CLAMP 11/16" to 1 1/2"
50-920	HOSE CLAMP 3/4" to 1 3/4"

RISER 3/8" C x 1/2" C

VINYL BRAIDED



P/N	LENGTH
21-78920	20 inch
21-78972	72 inch

REDLINE High-Performance



P/N	LENGTH
21-78972R	72 inch

STAINLESS STEEL BRAIDED



P/N	LENGTH
21-892760	60 inch
21-892772	72 inch

RISER 3/8" C x Brass BC

STAINLESS STEEL BRAIDED



P/N	LENGTH
21-83509	9 inch
21-83512	12 inch
21-83516	16 inch
21-83520	20 inch

RISER 3/8" C x 1/2" FIP

VINYL BRAIDED



P/N	LENGTH
21-78309	9 inch
21-78312	12 inch
21-78316	16 inch
21-78320	20 inch
21-78324	24 inch
21-78330	30 inch
21-78336	36 inch
21-78348	48 inch
21-78360	60 inch
21-78372	72 inch
21-78396	96 inch

STAINLESS STEEL BRAIDED



P/N	LENGTH
21-82309	9 inch
21-82312	12 inch
21-82316	16 inch
21-82320	20 inch
21-82324	24 inch
21-82330	30 inch
21-82336	36 inch
21-82348	48 inch
21-82360	60 inch
21-82372	72 inch
21-82396	96 inch

RISER 3/8" C x Plastic BC

STAINLESS STEEL BRAIDED



P/N	LENGTH
21-83409	9 inch
21-83412	12 inch
21-83416	16 inch
21-83420	20 inch

VINYL BRAIDED



P/N	LENGTH
21-79409	9 inch
21-79412	12 inch
21-79416	16 inch
21-79420	20 inch

RISER 1/2"C x 1/2"C

VINYL BRAIDED

P/N	LENGTH
21-78820	20 inch
21-78824	24 inch
21-78830	30 inch
21-78836	36 inch
21-78860	60 inch
21-78872	72 inch
21-78896	96 inch

REDLINE High-Performance

P/N	LENGTH
21-78860R	60 inch
21-78872R	72 inch
21-78896R	96 inch

STAINLESS STEEL BRAIDED

P/N	LENGTH
21-82816	16 inch
21-82820	20 inch
21-82824	24 inch
21-82848	48 inch
21-82860	60 inch
21-82872	72 inch
21-82896	96 inch

RISER 1/2"FIP x 1/2"FIP
VINYL BRAIDED

P/N	LENGTH
21-78109	9 inch
21-78112	12 inch
21-78116	16 inch
21-78120	20 inch
21-78124	24 inch
21-78130	30 inch
21-78136	36 inch
21-78148	48 inch
21-78160	60 inch
21-78172	72 inch
21-78196	96 inch

STAINLESS STEEL BRAIDED

P/N	LENGTH
21-82109	9 inch
21-82112	12 inch
21-82116	16 inch
21-82120	20 inch
21-82124	24 inch
21-82130	30 inch
21-82136	36 inch
21-82148	48 inch
21-82160	60 inch
21-82172	72 inch
21-82196	96 inch

RISER 1/2"C x 1/2"FIP
STAINLESS STEEL BRAIDED

P/N	LENGTH
21-82709	9 inch
21-82712	12 inch
21-82716	16 inch
21-82720	20 inch
21-82724	24 inch
21-82730	30 inch
21-82736	36 inch
21-82748	48 inch
21-82760	60 inch
21-82772	72 inch

RISER 1/2"FIP x BC
VINYL BRAIDED

P/N	LENGTH
21-79209	9 inch
21-79212	12 inch
21-79216	16 inch
21-79220	20 inch

RISER 1/2"FIP x Plastic BC
STAINLESS STEEL BRAIDED

P/N	LENGTH
21-83209	9 inch
21-83212	12 inch
21-83216	16 inch
21-83220	20 inch















RISER 1/2"FIP x 3/4"FIP
STAINLESS STEEL BRAIDED

P/N	LENGTH
21-88118	18 inch
21-88120	20 inch
21-88124	24 inch
21-88130	30 inch
21-88136	36 inch





















RISER 1/2"FIP x Brass BC
STAINLESS STEEL BRAIDED

P/N	LENGTH
21-83309	9 inch
21-83312	12 inch
21-83316	16 inch
21-83320	20 inch
21-83324	24 inch

DRYER INSTALL KITS - GAS

P/N 03-570P				
P/N 03-506P				
P/N 03-505P				
P/N 03-508P				

DRYER INSTALL KITS - ELECTRIC

P/N 03-600-5P			
P/N 03-600P			
P/N 03-655P			
P/N 03-601P			
P/N 03-608P			
P/N 03-620-5P			
P/N 03-620P			

UL APPROVED FLEXIBLE FOIL DRYER DUCTING

BULK PACKAGING

P/N	SIZE
35-17425-5	4" X 25'
35-17450-5	4" X 50'



DUCTING KITS

P/N	SIZE
35-135-5FS	4" X 5' w/ Spring Clamps
35-138-5FS	4" X 8' w/ Spring Clamps



PRE-CUT

P/N	SIZE
35-105F-5	4" X 5'
35-108F-5	4" X 8'



FLEXIBLE FOIL DRYER DUCTING

BULK PACKAGING

P/N	SIZE
35-17325	3" X 25'
35-17425	4" X 25'
35-17450	4" X 50'
35-17525	5" X 25'
35-17625	6" X 25'
35-17725	7" X 25'



DUCTING KITS

P/N	SIZE
35-135FS	4" X 5' w/ Spring Clamps
35-138FS	4" X 8' w/ Spring Clamps



PRE-CUT

P/N	SIZE
35-105F	4" X 5'
35-108F	4" X 8'



FLEXIBLE PLASTIC DRYER DUCTING

BULK PACKAGING

P/N	SIZE
35-150	4" X 50'



VENT CLAMPS (4")

P/N	SIZE
35-01	Spring
35-02	Screw
50-964	Worm Gear



VENT BUCKETS



P/N	ITEM DESC
35-860F	10 1/2" x 4 3/4" w/ 5ft Foil Ducting & Clamps
35-870	6 1/2" Round w/ 5ft Plastic Ducting & Clamps
35-870F	6 1/2" Round w/ 5ft Foil Ducting & Clamps
35-875	6 1/2" Round (Bucket Only)

ELBOWS, EXTENSIONS and COUPLINGS (Aluminum)



P/N	ITEM DESC	SIZE
35-10103	EXTENSION COLLAR	XXXX
35-10108	CLOSE ELBOW	4"
35-10109	OFFSET WALL ELBOW	4"
35-10110	OFFSET DRYER ELBOW	4"
35-10137	COUPLING	4"

CORRUGATED ALUMINUM VENTING

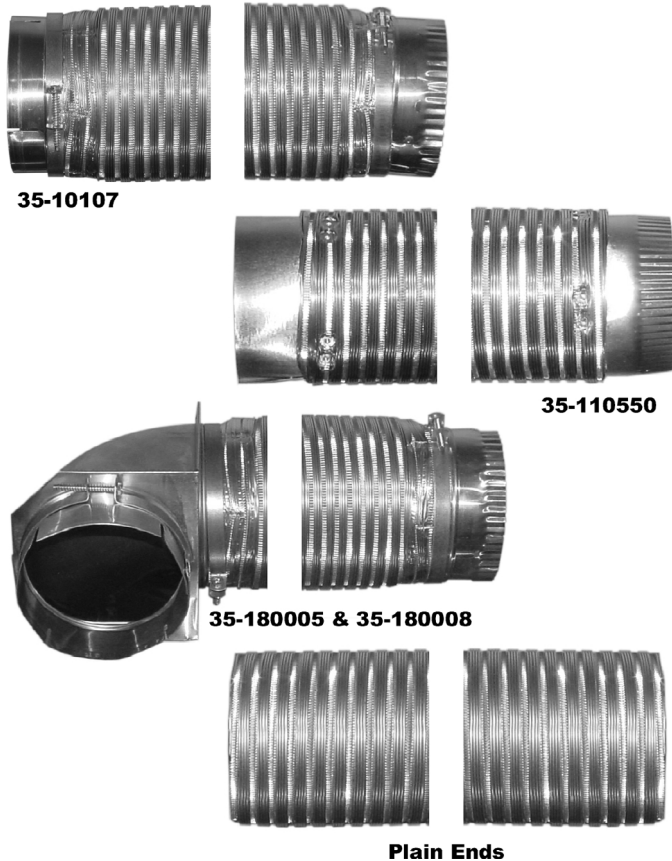

P/N	ITEM DESC
35-10107	4" x 6', M & F Ends, Screw Clamps
35-110550	4" x 4', M & F Ends (Slip-On)
35-180005	4" x 5' M & F Ends, Close Elbow, Screw Clamps
35-180008	4" x 8' M & F Ends, Close Elbow, Screw Clamps
35-18045/9	4" x 5', Plain Ends
35-18048/9	4" x 8', Plain Ends
35-18058/5	5" x 8', Plain Ends
35-18068/4	6" x 8', Plain Ends
35-18078/4	7" x 8', Plain Ends
35-18088/4	8" x 8', Plain Ends

VENT PIPE - GALVANIZED

ALUMINUM

P/N	SIZE
35-423	3" X 24"
35-424	4" X 24"

GALVANIZED

P/N	SIZE
35-413	3" X 36"
35-414	4" X 36"
35-415	5" X 36"
35-416	6" X 36"
35-417	7" X 36"
35-418	8" X 36"

ADJUSTABLE VENT ELBOWS

ALUMINUM

P/N	SIZE
35-314	4"
35-315	5"
35-316	6"
35-317	7"

GALVANIZED

P/N	SIZE
35-303	3"
35-304	4"
35-305	5"
35-306	6"
35-307	7"
35-308	8"

VENT REDUCERS and INCREASERS

GALVANIZED INCREASERS



P/N	SIZE
35-434	3" to 4"
35-445	4" to 5"
35-456	5" to 6"
35-457	5" to 7"
35-467	6" to 7"

GALVANIZED REDUCERS



P/N	SIZE
35-343	4" to 3"
35-354	5" to 4"
35-365	6" to 5"
35-375	7" to 5"
35-376	7" to 6"

TRANSITION ADAPTERS



35-507

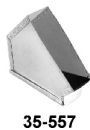

35-557



35-595

SHEET METAL

P/N	ITEM DESC	SIZE
35-505	STRAIGHT	5" x 3.25" x 10"
35-506	STRAIGHT	6" x 3.25" x 10"
35-507	STRAIGHT	7" x 3.25" x 10"
35-508	STRAIGHT	8" x 3.25" x 10"
35-550	EXTENSION	3.25" x 10" x 6"
35-555	ELBOW	3.25" x 10" x 90 deg
35-557	ELBOW	3.25" x 10" x 45 deg
35-595	RIGHT ANGLE	3.25" x 10" x 5"
35-596	RIGHT ANGLE	3.25" x 10" x 6"

VENT HOODS



35-800



35-812



35-845

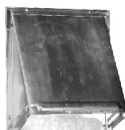

35-897

FOR THROUGH THE WALL INSTALLATION

P/N	ITEM DESC	SIZE
35-800	ALUMINUM REGULAR	4"
35-802	ALUMINUM BIG MOUTH	4"
35-810	PLASTIC REGULAR	4"
35-812	PLASTIC BIG MOUTH	4"
35-844	WHITE PLASTIC	4"
35-845	WHITE PLASTIC	5"
35-846	WHITE PLASTIC	6"
35-895	SPRING LOADED DAMPER	5"
35-896	SPRING LOADED DAMPER	6"
35-897	SPRING LOADED DAMPER	7"
35-898	SPRING LOADED DAMPER	8"

WALL CAPS

ALUMINUM WALL CAPS

P/N	SIZE
35-552	4"



PLASTIC WALL CAPS

P/N	SIZE
35-885	5"
35-885W	5"
35-886	6"

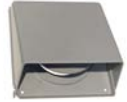

ALUMINUM TELESCOPING DUCT



P/N	ITEM DESC	SIZE
35-630	SIDE OUTLET	18" to 29"
35-648	SIDE OUTLET	24" to 41"
35-648S	BOTTOM OUTLET	28" to 43"
35-6E24	EXTENSION FOR ABOVE	24"

VENT STRAP

GALVANIZED 3/4" WIDE

P/N	ITEM DESC	SIZE
35-022	22 GAUGE	3/4" X 10 foot
35-026	26 GAUGE	3/4" X 10 foot
35-028	28 GAUGE	3/4" X 10 foot



DUET STACK KIT

P/N
35-8535926



LEVELING FEET



P/N	ITEM DESC
99-Z3392100	Plastic
99-Z-1X484	Foot Pad
99-Z-389102	Metal

COMPRESSION SLEEVES



BRASS

P/N	SIZE	U/M
05-60-3	3/16"	100L
05-60-4	1/4"	100L
05-60-5	5/16"	EACH
05-60-6	3/8"	100L
05-60-7	7/16"	EACH
05-60-8	1/2"	EACH

DELTRIN



P/N	SIZE	U/M
05-P60-4	1/4"	100L
05-P60-5	5/16"	EACH
05-P60-6	3/8"	100L
05-P60-8	1/2"	100L

TUBING INSERTS



BRASS

P/N	SIZE	U/M
05-63-4L	1/4" Long	100L
05-63-5	5/16"	EACH
05-63-6	3/8"	100L
05-63-8	1/2"	EACH

POLY

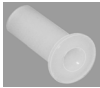

P/N	SIZE	U/M
15-1P-4	1/4"	EACH
15-1P-4L	1/4" Long	EACH
15-1P-5	5/16"	EACH
15-1P-6	3/8"	EACH
15-1P-6L	3/8" Long	EACH

COMPRESSION NUTS



BRASS

P/N	SIZE
05-61-2	1/8"
05-61-3	3/16"
05-61-4	1/4"
05-61-5	5/16"
05-61-6	3/8"
05-61-7	7/16"
05-61-8	1/2"

COMPRESSION CAPS



BRASS

P/N	SIZE
05-59-3	3/8"
05-59-4	1/4"
05-59-5	5/16"
05-59-6	3/8"
05-59-8	1/2"
05-59-4W	1/4" WASHER for 05-59-4

NYLON BALLS

P/N	SIZE
05-60B-4	1/4"
05-60B-6	3/8"



COMPRESSION UNIONS

P/N	SIZE
05-62-2	1/8"
05-62-3	3/16"
05-62-4	1/4"
05-62-5	5/16"
05-62-6	3/8"
05-62-7	7/16"
05-62-8	1/2"



COMPRESSION REDUCING UNIONS

P/N	SIZE
05-62R-4-2	1/4" to 1/8"
05-62R-4-3	1/4" to 3/16"
05-62R-5-4	5/16" to 1/4"
05-62R-6-4	3/8" to 1/4"
05-62R-6-5	3/8" to 5/16"
05-62R-8-6	1/2" to 3/8"
05-62R-10-6	5/8" to 3/8"
05-62R-10-8	5/8" to 1/2"



COMPRESSION ELBOWS

P/N	SIZE
05-65-3	3/16"
05-65-4	1/4"
05-65-5	5/16"
05-65-6	3/8"
05-65-7	7/16"
05-65-8	1/2"



FEMALE COMPRESSION to MALE COMPRESSION

STRAIGHT

P/N	SIZE
05-57-4-6	1/4" Female C x 3/8" Male C
05-57-6-4	3/8" Female C x 1/4" Male C
05-57-6-8	3/8" Female C x 1/2" Male C
05-57-8-6	1/2" Female C x 3/8" Male C
05-57-4W	Washer for 05-57-4-6
05-57-6W	Washer for 05-57-6-x
05-57-8W	Washer for 05-57-8-6



ELBOW

P/N	SIZE
05-57L-4-4	1/4" FIP X 1/4" MIP



COMPRESSION to FIP ADAPTER



P/N	SIZE
05-66-2-2	1/8"C X 1/8" FIP
05-66-3-2	3/16"C X 1/8" FIP
05-66-3-3	3/16"C X 3/16" FIP
05-66-3-4	3/16"C X 1/4" FIP
05-66-4-2	1/4"C X 1/8" FIP
05-66-4-4	1/4"C X 1/4" FIP
05-66-4-6	1/4"C X 3/8" FIP
05-66-4-8	1/4"C X 1/2" FIP
05-66-5-2	5/16"C X 1/8" FIP
05-66-5-4	5/16"C X 1/4" FIP
05-66-6-2	3/8"C X 1/8" FIP
05-66-6-4	3/8"C X 1/4" FIP
05-66-6-6	3/8"C X 3/8" FIP
05-66-6-8	3/8"C X 1/2" FIP
05-66-8-2	1/2"C X 1/8" FIP
05-66-8-4	1/2"C X 1/4" FIP
05-66-8-6	1/2"C X 3/8" FIP
05-66-8-8	1/2"C X 1/2" FIP

COMPRESSION to MIP ADAPTER



P/N	SIZE
05-68-2-2	1/8"C X 1/8" MIP
05-68-3-2	3/16"C X 1/8" MIP
05-68-3-4	3/16"C X 1/4" MIP
05-68-4-2	1/4"C X 1/8" MIP
05-68-4-4	1/4"C X 1/4" MIP
05-68-4-6	1/4"C X 3/8" MIP
05-68-4-8	1/4"C X 1/2" MIP
05-68-5-2	5/16"C X 1/8" MIP
05-68-5-4	5/16"C X 1/4" MIP
05-68-5-6	5/16"C X 3/8" MIP
05-68-5-8	5/16"C X 1/2" MIP
05-68-6-2	3/8"C X 1/8" MIP
05-68-6-4	3/8"C X 1/4" MIP
05-68-6-6	3/8"C X 3/8" MIP
05-68-6-8	3/8"C X 1/2" MIP
05-68-6-12	3/8"C X 3/4" MIP
05-68-7-4	7/16"C X 1/4" MIP
05-68-8-12	1/2"C X 3/4" MIP
05-68-8-4	1/2"C X 1/4" MIP
05-68-8-6	1/2"C X 3/8" MIP
05-68-8-8	1/2"C X 1/2" MIP
05-68-7-6	7/16"C X 3/8" MIP

COMPRESSION to FIP ADAPTER



P/N	SIZE
05-66SP-8-6	3/8"C x 1/2" FIP (7/16" SJ)

COMPRESSION to FIP ELBOW



P/N	SIZE
05-70-2-2	1/8"C X 1/8" FIP
05-70-3-2	3/16"C X 1/8" FIP
05-70-4-2	1/4"C X 1/8" FIP
05-70-4-4	1/4"C X 1/4" FIP
05-70-4-6	1/4"C X 3/8" FIP
05-70-4-8	1/4"C X 1/2" FIP
05-70-5-2	5/16"C X 1/8" FIP
05-70-5-4	5/16"C X 1/4" FIP
05-70-6-2	3/8"C X 1/8" FIP
05-70-6-4	3/8"C X 1/4" FIP
05-70-6-6	3/8"C X 3/8" FIP
05-70-6-8	3/8"C X 1/2" FIP
05-70-6-12	3/8"C X 3/4" FIP
05-70-7-4	7/16"C X 1/4" FIP
05-70-8-4	1/2"C X 1/4" FIP
05-70-8-6	1/2"C X 3/8" FIP
05-70-8-8	1/2"C X 1/2" FIP
05-70-8-12	1/2"C X 3/4" FIP

COMPRESSION to MIP ELBOW



P/N	SIZE
05-69-3-2	3/16"C X 1/8" MIP
05-69-3-4	3/16"C X 1/4" MIP
05-69-4-2	1/4"C X 1/8" MIP
05-69-4-4	1/4"C X 1/4" MIP
05-69-4-6	1/4"C X 3/8" MIP
05-69-4-8	1/4"C X 1/2" MIP
05-69-5-2	5/16"C X 1/8" MIP
05-69-5-4	5/16"C X 1/4" MIP
05-69-6-2	3/8"C X 1/8" MIP
05-69-6-4	3/8" C X 1/4" MIP
05-69-6-6	3/8"C X 3/8" MIP
05-69-6-8	3/8"C X 1/2" MIP
05-69-6-12	3/8"C X 3/4" MIP
05-69-7-4	7/16"C X 1/4" MIP
05-69-7-6	7/16"C X 3/8" MIP
05-69-8-4	1/2"C X 1/4" MIP
05-69-8-6	1/2"C X 3/8" MIP
05-69-8-8	1/2"C X 1/2" MIP
05-69-8-12	1/2"C X 3/4" MIP

COMPRESSION to FEMALE FLARE ADAPTER



P/N	SIZE
05-58-4CPR	1/4"C X 1/4" FIP

NO NUT OR SLEEVE

P/N	SIZE
05-B69-6-6	3/8"C X 3/8" MIP
05-B69-8-6	1/2"C X 3/8" MIP



COMPRESSION TEES



P/N	SIZE
05-64-2	1/8"
05-64-3	3/16"
05-64-4	1/4"
05-64-6	3/8"
05-64-7	7/16"
05-64-8	1/2"

COMPRESSION SUPPLY ADAPTERS

FEMALE BRANCH

P/N	SIZE
05-91-4F	3/8" C x 3/8" C x 1/4" C



MALE BRANCH

P/N	SIZE
05-91-4	3/8" C x 3/8" C x 1/4" C
05-91-6	3/8" C x 3/8" C x 3/8" C
05-91-8-4	1/2" C x 1/2" C x 1/4" C
05-91-8-6	1/2" C x 1/2" C x 3/8" C



COMPRESSION REDUCING TEES



P/N	SIZE
05-64R-442	1/4" X 1/4" X 1/8"
05-64R-443	1/4" X 1/4" X 3/16"
05-64R-446	1/4" X 1/4" X 3/8"
05-64R-554	5/16" X 5/16" X 1/4"
05-64R-644	3/8" X 1/4" X 1/4"
05-64R-664	3/8" X 3/8" X 1/4"
05-64R-884	1/2" X 1/2" X 1/4"
05-64R-886	1/2" x 1/2" x 3/8"

COMPRESSION to FIP BRANCH TEES



P/N	SIZE
05-77-4-2	1/4" C X 1/8" FIP
05-77-4-4	1/4" C X 1/4" FIP
05-77-6-2	3/8" C X 1/8" FIP
05-77-6-4	3/8" C X 1/4" FIP
05-77-8-2	1/2" C X 1/8" FIP
05-77-8-6	1/2" C X 3/8" FIP

COMPRESSION to MIP BRANCH TEES



P/N	SIZE
05-72-2-2	1/8" C X 1/8" MIP
05-72-3-2	3/16" C X 1/8" MIP
05-72-4-2	1/4" C X 1/8" MIP
05-72-4-4	1/4" C X 1/4" MIP
05-72-5-2	5/16" C X 1/8" MIP
05-72-5-4	5/16" C X 1/4" MIP
05-72-6-2	3/8" C X 1/8" MIP
05-72-6-4	3/8" C X 1/4" MIP
05-72-6-6	3/8" C X 3/8" MIP
05-72-6-8	3/8" C X 1/2" MIP
05-72-8-8	1/2" C X 1/2" MIP

COMPRESSION to MIP RUN TEES



P/N	SIZE
05-71-2-2	1/8" C X 1/8" MIP
05-71-3-2	3/16" C X 1/8" MIP
05-71-4-2	1/4" C X 1/8" MIP
05-71-4-4	1/4" C X 1/4" MIP
05-71-5-2	5/16" C X 1/8" MIP
05-71-5-4	5/16" C X 1/4" MIP
05-71-6-2	3/8" C X 1/8" MIP
05-71-6-4	3/8" C X 1/4" MIP
05-71-6-6	3/8" C X 3/8" MIP
05-71-8-6	1/2" C X 3/8" MIP
05-71-8-8	1/2" C X 1/2" MIP

FLARE NUTS REGULAR PATTERN



P/N	SIZE
05-41S-3	3/16"
05-41S-4	1/4"
05-41S-6	3/8"
05-41S-8	1/2"
05-41S-10	5/8"

FLARE NUTS LONG PATTERN



P/N	SIZE
05-41L-2	1/8"
05-41L-4	1/4"
05-41L-6	3/8"
05-41L-10	5/8"

FLARE NUTS FORGED HEAVY DUTY



P/N	SIZE
05-413-4	1/4"
05-413-6	3/8"
05-413-8	1/2"
05-413-10	5/8"

FLARE CAPS



P/N	SIZE
05-40-4	1/4"
05-40-6	3/8"
05-40-8	1/2"
05-40-10	5/8"
05-40-12	3/4"
01-698	15/16"

FLARE PLUGS



P/N	SIZE
05-39-4	1/4"
05-39-6	3/8"
05-39-8	1/2"
05-39-10	5/8"

FLARE UNIONS

P/N	SIZE
05-42-4	1/4"
05-42-6	3/8"
05-42-8	1/2"
05-42-10	5/8"
05-42-12	3/4"
05-42-14	7/8"



FLARE UNIONS - REDUCING

P/N	SIZE
05-42R-6-4	3/8" to 1/4"
05-42R-8-6	1/2" to 3/8"
05-42R-10-6	5/8" to 3/8"
05-42R-12-8	3/4" to 1/2"



FLARE UNIONS - SWIVEL

P/N	SIZE
05-52-4	1/4"
05-52-6	3/8"
05-52-8	1/2"
05-52-10	5/8"



FLARE to FIP



P/N	SIZE
05-46-4-2	1/4" X 1/8" FIP
05-46-4-4	1/4" X 1/4" FIP
05-46-4-6	1/4" X 3/8" FIP
05-46-4-8	1/4" X 1/2" FIP
05-46-6-2	3/8" X 1/8" FIP
05-46-6-4	3/8" X 1/4" FIP
05-46-6-6	3/8" X 3/8" FIP
05-46-6-8	3/8" X 1/2" FIP
05-46-6-12	3/8" X 3/4" FIP
05-46-8-6	1/2" X 3/8" FIP
05-46-8-8	1/2" X 1/2" FIP
05-46-8-12	1/2" X 3/4" FIP
05-46-10-8	5/8" X 1/2" FIP
05-46-10-12	5/8" X 3/4" FIP

FLARE to MIP



P/N	SIZE
05-48-4-2	1/4" X 1/8" MIP
05-48-4-4	1/4" X 1/4" MIP
05-48-4-6	1/4" X 3/8" MIP
05-48-4-8	1/4" X 1/2" MIP
05-48-6-2	3/8" X 1/8" MIP
05-48-6-4	3/8" X 1/4" MIP
05-48-6-6	3/8" X 3/8" MIP
05-48-6-8	3/8" X 1/2" MIP
05-48-6-12	3/8" X 3/4" MIP
05-48-8-6	1/2" X 3/8" MIP
05-48-8-8	1/2" X 1/2" MIP
05-48-8-12	1/2" X 3/4" MIP
05-48-10-4	5/8" X 1/4" MIP
05-48-10-6	5/8" X 3/8" MIP
05-48-10-8	5/8" X 1/2" MIP
05-48-10-12	5/8" X 3/4" MIP
05-48-14-8	7/8" X 1/2" MIP

FLARE to FIP ELBOWS



P/N	SIZE
05-50-6-4	3/8" X 1/4" FIP
05-50-6-6	3/8" X 3/8" FIP
05-50-6-8	3/8" X 1/2" FIP
05-50-8-6	1/2" X 3/8" FIP
05-50-8-8	1/2" X 1/2" FIP
05-50-8-12	1/2" X 3/4" FIP

FLARE to MIP ELBOWS



P/N	SIZE
05-49-4-4	1/4" X 1/4" MIP
05-49-6-2	3/8" X 1/8" MIP
05-49-6-4	3/8" X 1/4" MIP
05-49-6-6	3/8" X 3/8" MIP
05-49-6-8	3/8" X 1/2" MIP
05-49-8-4	1/2" X 1/4" MIP
05-49-8-6	1/2" X 3/8" MIP
05-49-8-8	1/2" X 1/2" MIP
05-49-8-12	1/2" X 3/4" MIP
05-49-10-8	5/8" X 1/2" MIP

FEMALE FLARE to MALE FLARE

















P/N	SIZE
05-54-6-4	3/8" X 1/4"
05-54-6-8	3/8" X 1/2"
05-54-8-6	1/2" X 3/8"
05-54-8-10	1/2" X 5/8"
05-54-10-8	5/8" X 1/2"
05-54-10-12	5/8" X 3/4"

FLARE (FEMALE) to MIP ELBOW



P/N	SIZE
05-49-4-6F	1/4" X 3/8"

SUPPLY STOPS & W/M VALVES

IMPORT	ANGLE BRASS NOM 	ANGLE BRASS FIP 	
	DUAL ANGLE BRASS NOM 	DUAL ANGLE BRASS FIP 	
IMPORT 1/4 TURN	ANGLE CHROME NOM 	ANGLE CHROME FIP 	
	DUAL ANGLE CHROME NOM 	DUAL ANGLE CHROME FIP 	
ARCO 1/4 TURN	ANGLE CHROME NOM 	ANGLE CHROME FIP 	
	STRAIGHT CHROME NOM 	STRAIGHT CHROME FIP 	
	WASH MACH CHROME NOM 	WASH MACH CHROME FIP 	WASH MACH CHROME MIP 

ANGLE STOP - BRASS

P/N	INLET	OUTLET	MFR
21-3844	1/2"NOM	1/4"C	IMPORT
21-3846	1/2"NOM	3/8"C	IMPORT
21-3804	1/2"FIP	1/4"C	IMPORT
21-3806	1/2"FIP	3/8"C	IMPORT
21-3808	1/2"FIP	1/2"C	IMPORT

DUAL ANGLE STOP - BRASS

P/N	INLET	OUTLET	MFR
21-2564	1/2"NOM	1/4"C & 3/8"C	IMPORT
21-2566	1/2"NOM	3/8"C & 3/8"C	IMPORT
21-2864	1/2"FIP	1/4"C & 3/8"C	IMPORT
21-2866	1/2"FIP	3/8"C & 3/8"C	IMPORT

ANGLE STOP - CHROME

P/N	INLET	OUTLET	MFR
21-3944	1/2"NOM	1/4"C	IMPORT
21-3946	1/2"NOM	3/8"C	IMPORT
21-3341	1/2"NOM	7/16"-1/2" S.J.	IMPORT
21-3904	1/2"FIP	1/4"C	IMPORT
21-3906	1/2"FIP	3/8"C	IMPORT
21-3301	1/2"FIP	7/16"-1/2" S.J.	IMPORT

ANGLE STOP - CHROME - 1/4 TURN

P/N	INLET	OUTLET	MFR
21-AB44BK	1/2"NOM	1/4"C	IMPORT
21-AB46BK	1/2"NOM	3/8"C	IMPORT
21-1900	1/2"NOM	3/8"C	ARCO
21-1902	1/2"NOM	7/16"-1/2" S.J.	ARCO
21-1901	1/2"FIP	3/8"C	ARCO
21-1903	1/2"FIP	7/16"-1/2" S.J.	ARCO

**DUAL ANGLE STOP - CHROME
1/4 TURN**

P/N	INLET	OUTLET	MFR
21-DB464BK	1/2"NOM	1/4"C & 3/8"C	IMPORT
21-DB466BK	1/2"NOM	3/8"C & 3/8"C	IMPORT
21-DB764BK	1/2"FIP	1/4"C & 3/8"C	IMPORT
21-DB766BK	1/2"FIP	3/8"C & 3/8"C	IMPORT

STRAIGHT STOP- CHROME-1/4 TURN

P/N	INLET	OUTLET	MFR
21-1910	1/2"NOM	3/8"C	ARCO
21-1911	1/2"FIP	3/8"C	ARCO

WASHING MACHINE - 1/4 TURN

P/N	INLET	OUTLET	MFR
21-WMV2000	1/2"NOM	HOSE	ARCO
21-WMV3000	1/2"FIP	HOSE	ARCO
21-1919	1/2"MIP	HOSE	ARCO
21-1920	3/4"MIP	HOSE	ARCO

SUPPLY ADAPTERS - SLIP JOINT



1/2" SJ x 1/2" SJ w/ WASHERS

P/N	FINISH	OUTLET
05-92S8BR	BRASS	1/8" FIP
05-92S8	BRASS	1/8" FIP
05-92S8CH	CHROME	1/8" FIP
05-92S4	BRASS	1/4" FIP



1/2" SJ x 1/2" SJ no WASHERS

P/N	FINISH	OUTLET
05-92S1/8	BRASS	1/8" FIP
05-92S1/4	BRASS	1/4" FIP

WASHERS for SJ SUPPLY ADAPTERS



P/N	ITEM DESC
05-5967	CONE WASHERS
05-9W	FLAT WASHERS

SUPPLY ADAPTERS - COMPRESSION



3/8" Male C x 3/8" Female C

P/N	ITEM DESC
05-91-4	1/4" C
05-91-4F	1/4" Female C
05-91-6	3/8" C
05-92C6-2	1/8" FIP
05-92C6-4	1/4" FIP
05-92C6W	Washer for 05-92C6-x



1/2" Male C x 1/2" Female C

P/N	OUTLET
05-91-8-4	1/4" C
05-91-8-6	3/8" C

SUPPLY ADAPTERS - PIPE THREAD



P/N	ITEM DESC	FINISH
05-92C8	1/2" FIP x 1/2" MIP x 1/8" FIP	BRASS
05-93C8	3/4" FIP x 3/4" MIP x 1/8" FIP	BRASS
05-94C8	3/4" FHT x 3/4" MHT x 1/8" FIP	BRASS
05-92-8-4	3/4" FIP x 3/4" MIP x 1/4" C	BRASS
05-92-8-6	1/2" FIP x 1/2" MIP x 3/8" C	BRASS
05-92CW	WASHERS for 05-92 Series	

SUPPLY ADAPTERS - HOSE



P/N	ITEM DESC
05-95-4	FHT x 1/4" C
05-95-4L	FHT x 1/4" C Elbow
50-NC2098	FHT x 1/4" John Guest

HOSE CAPS



P/N	ITEM DESC
50-4001	HOSE CAP w/ 1/8" FIP Tap
50-4002	HOSE CAP w/ 1/4" FIP Tap
50-4000	HOSE CAP
50-4000W	HOSE CAP w/ Washer

EZ SUPPLY ADAPTER KITS - 1/2" S.J.



**CHROME ADAPT
1/4" C CHROME BALL VALVE**
P/N SIZE
05-92S8CHKZ 1/2" MSJ x 1/2" FSJ X 1/4" C



**CHROME ADAPT
1/4" C CHROME NEEDLE VALVE**
P/N SIZE
05-92S8CHNZ 1/2" MSJ x 1/2" FSJ X 1/4" C



**BRASS ADAPT
1/4" C CHROME BALL VALVE**
P/N SIZE
05-92S8BKZ 1/2" MSJ x 1/2" FSJ X 1/4" C



**BRASS ADAPT
1/4" C BRASS NEEDLE VALVE**
P/N SIZE
05-92S8KZ 1/2" MSJ x 1/2" FSJ X 1/4" C



**BRASS ADAPT
1/4" FIP BRASS BALL VALVE**
P/N SIZE
05-92S4BKZ 1/2" MSJ x 1/2" FSJ X
1/4" FIP



**BRASS ADAPT
1/4" JOHN GUEST ADAPTER**
P/N SIZE
05-92S4GZ 1/2" MSJ x 1/2" FSJ X
1/4" JG



**BRASS ADAPT
3/8" C BRASS NEEDLE VALVE**
P/N SIZE
05-92S4KZ 1/2" MSJ x 1/2" FSJ X 3/8" C



**PLASTIC ADAPT
JOHN GUEST ADAPTER**
P/N SIZE
16-EZKIT1/4 1/2" MSJ x 1/2" FSJ X
1/4" JG
16-EZKIT3/8 1/2" MSJ x 1/2" FSJ X
3/8" JG

MISTER DRAIN



P/N
50-6095

EZ SUPPLY ADAPTER KITS - 3/8" C



BRASS ADAPT 1/4" FIP BRASS BALL VALVE
P/N SIZE
05-91-4FBKZ 3/8" FC X 3/8" MC X 1/4" FIP



BRASS ADAPT 1/4" JOHN GUEST ADAPTER
P/N SIZE
05-91-4FGZ 3/8" FC X 3/8" MC X 1/4" JG

SUPPLY ADAPTERS



For 1/2" - 3/4" Pipe

P/N	SIZE
05-800	w/ 1/4" C Needle Valve
05-809	w/ 1/4" C Needle Valve
05-810	w/ 1/4" C Needle Valve
05-808	Body only
05-808-BVZ	w/ 1/4" C Ball Valve

DRAIN SADDLES



P/N	ITEM DESC
05-834	1/4" FIP
05-836	3/8" FIP
05-834J	1/4" Jaco
05-836J	3/8" Jaco
05-834JG	1/4" John Guest
05-836JG	3/8" John Guest
05-850	1/4" Compression
05-820	1/2" FIP - for 1 1/2" Tube
05-824	1/2" FIP - for 1 1/2" Pipe

WASHING MACHINE FILL HOSE



RUBBER HIGH-PRESSURE

P/N	ITEM DESC
50-103	3 foot - FHT x FHT
50-104	4 foot - FHT x FHT
50-105	5 foot - FHT x FHT
50-106	6 foot - FHT x FHT
50-108	8 foot - FHT x FHT
50-1010	10 foot - FHT x FHT



RUBBER HIGH-PRESSURE w/ 90 degree ELBOW

P/N	ITEM DESC
50-123	3 foot - FHT x FHT
50-124	4 foot - FHT x FHT
50-125	5 foot - FHT x FHT
50-126	6 foot - FHT x FHT
50-128	8 foot - FHT x FHT



STAINLESS STEEL BRAIDED

P/N	ITEM DESC
50-184	4 foot - FHT x FHT
50-185	5 foot - FHT x FHT
50-186	6 foot - FHT x FHT



STAINLESS STEEL BRAIDED LARGE MOUTH

P/N	ITEM DESC
50-L48SS	4 foot - FHT x FHT
50-L60SS	5 foot - FHT x FHT
50-L72SS	6 foot - FHT x FHT



STAINLESS STEEL BRAIDED w/ 90 degree ELBOW

P/N	ITEM DESC
50-174	4 foot - FHT x FHT
50-175	5 foot - FHT x FHT

WASHING MACHINE EXT. HOSE



RUBBER HIGH-PRESSURE

P/N	ITEM DESC
50-162	2 foot - MHT x FHT
50-163	3 foot - MHT x FHT
50-164	4 foot - MHT x FHT
50-165	5 foot - MHT x FHT

WASHERS



P/N	ITEM DESC
50-190	'GREEN STRIPE' (100 lot)
50-195	COARSE SCREEN WASHER
50-196	FINE SCREEN WASHER

HOSE ADAPTERS



P/N	ITEM DESC
50-4103	3/4" MHT x 3/4" MIP (Brass)
50-2055	HOSE MENDER (Plastic)
50-81-12-12	3/4" MHT x 3/4" BARB (Brass)
50-4501	3/4" MHT x 3/4" MHT (Brass)
50-4900	SIAMESE HOSE 'Y' (Brass)

WASHING MACHINE DRAIN HOSE

CORRUGATED

P/N	ITEM DESC
50-2000	6 foot
50-2001	8 foot



HOSE CLAMPS - WORM GEAR

STAINLESS STEEL BAND & HOUSING - PLATED SCREW

P/N	MIN DIA	MAX DIA
50-906	3/8"	7/8"
50-908	7/16"	1"
50-910	1/2"	1 1/16"
50-912	1/2"	1 1/4"
50-916	11/16"	1 1/2"
50-920	3/4"	1 3/4"
50-924	1"	2"
50-928	1 1/4"	2 1/4"
50-932	1 1/2"	2 1/2"
50-936	1 3/4"	2 3/4"
50-940	2"	3"
50-944	2 1/4"	3 1/4"
50-948	2 1/2"	3 1/2"
50-952	2 3/4"	3 3/4"
50-956	3"	4"
50-964	2 1/2"	4 1/2"
50-972	3"	5"
50-980	3 1/2"	5 1/2"
50-988	4"	6"
50-996	4 1/2"	6 1/2"



HOSE CLAMPS (mini) - WORM GEAR

STAINLESS STEEL BAND & HOUSING - PLATED SCREW

P/N	MIN DIA	MAX DIA
50-9M5	1/4"	11/16"
50-9M6	5/16"	7/8"
50-9M8	3/8"	1"
50-9M9	1/2"	1 1/8"



JOHN GUEST FITTINGS

MIP ADAPTER



P/N	SIZE
16-G01-4-4	1/4" JG x 1/4" MIP
16-G01-4-6	1/4" JG x 3/8" MIP
16-G01-5-4	5/16" JG x 1/4" MIP
16-G01-6-4	3/8" JG x 1/4" MIP
16-G01-6-6	3/8" JG x 3/8" MIP

TEE



P/N	SIZE
16-G02-4	1/4"
16-G02-6	3/8"

UNION ELBOW



P/N	SIZE
16-G03-4	1/4" JG x 1/4" JG
16-G03-5	5/16" JG x 5/16" JG
16-G03-6	3/8" JG x 3/8" JG

UNION



P/N	SIZE
16-G04-4	1/4" JG x 1/4" JG
16-G04-5	5/16" JG x 5/16" JG
16-G04-6	3/8" JG x 3/8" JG

STEM ADAPTER



P/N	SIZE
16-G05-4-4	1/4" OD Stem x 1/4" MIP
16-G05-6-4	3/8" OD Stem x 1/4" MIP
16-G05-6-6	3/8" OD Stem x 3/8" MIP

STEM PLUG



P/N	SIZE
16-G08-4	1/4"
16-G08-6	3/8"

LOCKING CLIP



P/N	SIZE
16-G1808	1/4"
16-G1810	5/16"
16-G1812	3/8"

REDUCING UNION



P/N	SIZE
16-G20-5-4	5/16" JG x 1/4" JG
16-G20-6-4	3/8" JG x 1/4" JG
16-G20-6-5	3/8" JG x 5/16" JG

PLUG-IN ELBOW



P/N	SIZE
16-G22-4-4	1/4" Stem x 1/4" JG
16-G22-6-4	3/8" Stem x 1/4" JG
16-G22-6-6	3/8" Stem x 3/8" JG

JOHN GUEST FITTINGS

FIP ADAPTER



P/N	SIZE
16-G45-4-4	1/4" JG x 1/4" FIP
16-G45-6-4	3/8" JG x 1/4" FIP

END STOP



P/N	SIZE
16-G46-4	1/4"
16-G46-5	5/16"
16-G46-6	3/8"

MIP ELBOW



P/N	SIZE
16-G48-4-4	1/4" JG x 1/4" MIP
16-G48-4-6	1/4" JG x 3/8" MIP
16-G48-5-4	5/16" JG x 3/8" MIP
16-G48-5-6	5/16" JG x 3/8" MIP
16-G48-6-4	3/8" JG x 1/4" MIP
16-G48-6-6	3/8" JG x 3/8" MIP

TUBING

COPPER (Refrigerator)

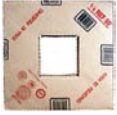

P/N	ITEM DESC
04-104	1/4" x 50'
04-106	3/8" x 50'

ALUMINUM



P/N	ITEM DESC
04-404	1/4" x 0.32Wall x 50ft
04-406	3/8" x 0.35Wall x 50ft

POLYVINYL - FDA APPROVED



P/N	ITEM DESC
04-204	1/4"ID x 3/8"OD x 100' - Clear
04-206	3/8"ID x 1/2"OD x 100' - Clear
04-208	1/2"ID x 5/8"OD x 100' - Clear
04-208-HD	1/2"ID x 3/4"OD x 100' - Clear
04-211-HDBK	1/2"ID x 3/4"OD x 100' - Black

JOHN GUEST - FDA APPROVED



P/N	ITEM DESC
04-32500W	1/4" x 500' - White
04-32500BL	1/4" x 500' - Blue
04-32500BLK	1/4" x 500' - Black
04-32500N	1/4" x 500' - Natural
04-32500G	1/4" x 500' - Green
04-32500R	1/4" x 500' - Red
04-33500W	3/8" x 500' - White
04-33500BL	3/8" x 500' - Blue
04-33500BLK	3/8" x 500' - Black
04-33500N	3/8" x 500' - Natural
04-33500Y	3/8" x 500' - Yellow
04-33500R	3/8" x 500' - Red

PARKER - FDA APPROVED



P/N	ITEM DESC
04-44-0100W	1/4" x 100' - Natural
04-44-0100L	1/4" x 100' - Blue
04-44-0100B	1/4" x 100' - Black
04-44-0100R	1/4" x 100' - Red
04-44-100GR	1/4" x 100' - Gray
04-44-0500W	1/4" x 500' - Natural
04-44-0500L	1/4" x 500' - Blue
04-44-0500B	1/4" x 500' - Black
04-45-0100W	5/16" x 100' - Natural
04-45-0100B	5/16" x 100' - Black
04-46-0100W	3/8" x 100' - Natural
04-46-0100L	3/8" x 100' - Blue
04-46-0100B	3/8" x 100' - Black
04-46-100GR	3/8" x 100' - Gray
04-46-0500W	3/8" x 500' - Natural
04-46-0500L	3/8" x 500' - Blue
04-46-0500B	3/8" x 500' - Black
04-46-500GR	3/8" x 500' - Gray
04-48-0100B	1/2" x 100' - Black
04-48-100GR	1/2" x 100' - Gray
04-49-0100W	5/8" x 100' - Natural
04-49-0100B	5/8" x 100' - Black

TUBING CUTTER

P/N
15-PTC-001



SLEEVES

DELRIN

P/N	ITEM DESC
05-P60-4	1/4"
05-P60-5	5/16"
05-P60-6	3/8"
05-P60-8	1/2"



INSERTS

DELRIN

P/N	ITEM DESC
15-1P-4L	1/4" (Long)
15-1P-5	5/16"
15-1P-6L	3/8" (Long)



TOUCH-UP PAINT

BOTTLE w/ DAUBER

P/N	ITEM DESC
88-72017	White, 0.6oz
88-92899	Bisque, 0.6oz
88-72032	Black, 0.6oz
88-80051	Graphite, 0.6oz
88-72107	Almond, 0.6oz



SPRAY CAN

P/N	ITEM DESC
88-350930	White, 12oz
88-4392901	Bisque, 12oz
88-285006	Black, 12oz
88-4396174	Pewter, 12oz
88-8171357	Graphite, 12oz
88-350956	Almond, 12oz



LUBRICANT

ZOOM SPOUT

P/N	ITEM DESC
86-1000	4 oz



RUST BUSTER

P/N	ITEM DESC
86-2000	4 oz



WD-40

P/N	ITEM DESC
86-3002	2 oz
86-3009	8 oz
86-3012	12 oz
86-3016	16 oz



DOW CORNING SILICONE

P/N	ITEM DESC
86-1111	5.3 oz



TAPE

MASKING TAPE

P/N	ITEM DESC
92-0012	3/4" x 60yds
92-0016	1" x 60yds
92-0024	1 1/2" x 60yds
92-0032	2" x 60yds



TAPE DISPENSER

P/N	ITEM DESC
92-0500	Boxed



CARTON SEALING - CLEAR

P/N	ITEM DESC
92-0600	2" x 55yds



FILAMENT TAPE

P/N	ITEM DESC
92-0812	3/4" x 60yds
92-0816	1" x 60yds
92-0824	1 1/2" x 60yds
92-0832	2" x 60yds



DUCT TAPE

P/N	ITEM DESC
92-1032	2" x 60yds - Medium Grade
92-2032	2" x 60yds - Premium Grade

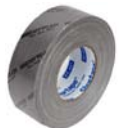

ELECTRICAL TAPE

P/N	ITEM DESC
92-3000	3/4" x 60'



METALIZED TAPE

P/N	ITEM DESC
92-AF973	2" x 50yds - Aluminum Foil
92-SF683	2" x 60yds - Hvy Duty Metalized



PIPE WRAPPING

P/N	ITEM DESC
49-5251	1" x 100' x 10mil
49-5252	2" x 100' x 10mil
49-5254	4" x 100' x 10mil
49-5362	2" x 100' x 20mil



EASY SLIDER



P/N	ITEM DESC
99-EASY	EASY SLIDER

FOREARM FORKLIFT



P/N	ITEM DESC
98-NH536-OR	Orange Straps

SHOE PROTECTOR



P/N	ITEM DESC
98-SB-ASST	Assorted Colors
98-SB-WP-B	Waterproof - Blue, 150 Pair
98-SB-WP-50	Waterproof - Blue, 50 Pair
98-SB-B	Blue - 150 Pair
98-SB-DB	Dark Blue, 150 Pair
98-SB-G	Green, 150 Pair
98-SB-Y	Yellow, 150 Pair
98-SB-B-50	Blue - 50 Pair
98-SB-DB-50	Dark Blue, 50 Pair
98-SB-G-50	Green, 50 Pair
98-SB-Y-50	Yellow, 50 Pair

APPLIANCE PADS



P/N	ITEM DESC
97-FC1000	Washer, Dryer Range 46" x 38" 32"
97-FC1001	Refrigerator. 64" x 33" x 33", w/ Velcro
97-FC1005	Door Jamb Protector

TIE STRAP



P/N	ITEM DESC
98-3700	Cotton, 2" x 100 feet
98-3710	Nylon, 1" x 150 feet

ROPE -TWISTED POLYPRO



P/N	ITEM DESC
98-3730	3/8" x 600 feet

TIE DOWN STRAP



P/N	ITEM DESC
98-3981	15"
98-3982	21"
98-3983	31"

GLOVE

P/N	ITEM DESC
99-GLOVE	Heavy Duty Canvas



FURNITURE PAD

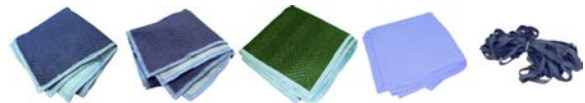

P/N	ITEM DESC
97-FP2000	72" x 80", 80 lbs per dozen
97-FP2001	72" x 80", 75 lbs per dozen
97-FP2002	72" x 80", 64 lbs per dozen
97-FP2003	72" x 80", 40 lbs per dozen
97-MA9100	42" Hvy Duty Rubber Band for Furniture Pads

SHRINK WRAP



P/N	ITEM DESC
97-MA0104	12" x 1500 feet
99-Z9999090	18" x 1500 feet
98-222	Dispensing Handle

CAM BUCKLE STRAP - 800 lbs Load

P/N	ITEM DESC
97-CC2000	Cam Buckle Strap, 2" x 12", Yellow
97-CC2001	Cam Buckle Strap, 2" x 16", Gray



DOLLY - CARPETED



P/N	ITEM DESC
97-FD4002	Hardwood, 18" x 32"

DOLLY - YEATS



DOLLY



97-HT6001



97-HT6003



97-HT6004

P/N	ITEM DESC
97-HT6001	Aluminum, Single-Grip
97-HT6003	Steel Handle Loop
97-HT6004	Aluminum, Double-Grip

P/N	ITEM DESC
98-105	"Shorty" 47" high
98-107	"Standard" 58" high
98-109	"Maxi" 71" high
98-114	"Dualie" (2 ratchets)
98-116	"Superman" (2 ratchets, 5 positions, & more)
98-120	Big Wheel Attachment - 10" air tires

DOLLY - YEATS, REPAIR PARTS

P/N ITEM DESC

98-0101	(1) TOP HANDLE
98-0131	(2L) SIDE RAIL - LEFT
98-0132	(2R) SIDE RAIL - RIGHT
98-0103	(3) SPACER
98-0135	(3A) SPACER BOLT
98-0104	(4) CROSS MEMBER w/o thumb latch
98-0106	(6) SIDE HANDLE
98-0107	(7) RATCHET HANDLE w/ spring
98-0137	(7A) RATCHET RETURN SPRING
98-0108	(8) CROSS MEMBER w/ thumb latch
98-0109	(9) THUMB LATCH w/ bracket & spring
98-0138	(9A) THUMB LATCH SPRING
98-0110	(10) VERTICAL SHAFT & HOLDING GEAR
98-0139	(10A) HOLDING GEAR w/ pin
98-0111	(11) DOLLY STRAP 15 foot
98-0111-21	(11) DOLLY STRAP 21 foot
98-0112	(12) DOLLY STRAP SUPPORT ROD
98-0114	(14) TOP PULLEY
98-0140	(15L) GLIDE SLIDE - LEFT
98-0141	(15R) GLIDE SLIDE - RIGHT
98-0116	(16) GLIDE BELT
98-0117L	(17L) AXLE BRACKET - LEFT
98-0117R	(17R) AXLE BRACKET - RIGHT
98-0145	(19L) SLIDE RAIL BASE - LEFT
98-0146	(19R) SLIDE RAIL BASE - RIGHT
98-0120	(20) LOWER PULLEY
98-0121	(21) AXLE
98-0150	(22) WHEEL w/ bearing
98-0151	(22A) WHEEL BEARING SLEEVE
98-0152	(22B) WHEEL BEARING
98-0123	(23) NOSE PLATE (specify model)
98-0160	(24A) FELT PAD SET w/ cement
98-0161	(24B) FELT PAD for Nose Plate
98-0162	(24C) FELT PAD for Side Rail
98-0163	(24D) FELT PAD for Cross Member
98-0164	(24E) RUBBER CEMENT
98-0170	(25) PLASTIC PAD SET w/ cement
98-0126	(26) THUMB LATCH w/ spring
98-0127	(27) REPLACEMENT TOP HANDLE
98-0000-xx	RIVET (specify by part)

